

# Phoenix III

A fifteen foot BeachrUISer for Sail, Oar, and Small Outboard

**Designed by Ross Lillistone**

*Phoenix III* was designed for the builder of the first boat, Paul Hernes. Paul came to me in search of plans for a dinghy which could be sailed fast and far, rowed in such a way as to be more pleasure than pain, and to be able to accommodate a small outboard motor if the conditions required it.

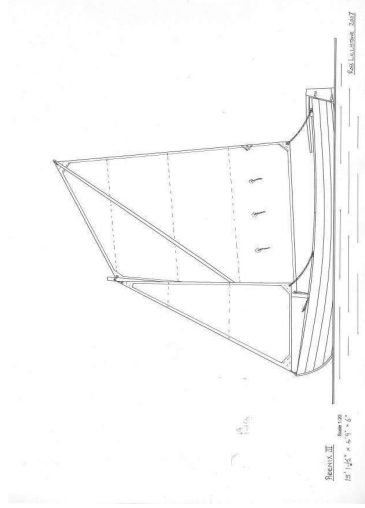

As it happened, I already had a design which I had been working on for many years. She was to be the perfect beachrUISer for my own use, incorporating my idea of the optimum physical dimensions for solo and two-up cruising.

I've long held the view that the smaller a boat is, the more she will be used, and with this in mind, *Phoenix III* has been kept to modest dimensions: -

- Length Over All  
15ft 1-1/2ins / 4610mm
- Breadth  
4ft 9in / 1457mm
- Draft  
6in / 153mm

- Weight approximately  
132lbs / 60kg
- Displacement  
595lbs / 270 kg
- Sail Area  
104sq.ft. / 9.64sq.m.

The shape of the hull is a compromise, as is the case with all boats. The breadth has been kept reasonably small so that she can be rowed efficiently with easy-to-stow 7-1/2 foot oars. A case could be made for a wider hull in order to increase initial stability and sail-carrying power, but I kept my nerve and stayed with a narrow boat. In addition to helping make the boat a pleasure to row, the slender breadth reduces weight, and results in a fine entry angle at the bow. The fine bow angle reduces pounding and helps to make her a dry boat.

For such a relatively narrow boat she is very stable, being able to carry the weight of a 90kg/200lb person sitting on the gunwale, without shipping water!

The hull structure of *Phoenix III* is unusually open and free of clutter, relying on built-in components such as watertight bulkheads, rowing thwart and centerboard case to add rigidity to the glued-lapstrake (clinker/plywood) skin. The glued-lapstrake construction method produces a stressed-skin hull with a very good stiffness-to-weight ratio, and the bonding of major components like the bulkheads adds greatly to the strength with little added weight.

She has been given a spritsail with a jib set flying (i.e. a jib which is not attached to a separate stay). The

spritsail sloop is one of the few sloop rigs which can carry a jib effectively without stays, shrouds or backstays of any type. This is because the sprit places the head of the mainsail in tension, which is in turn translated into tension in the luff of the jib. Therefore, there are no stays on this boat at all – just place the mast into the step and partner, and off you go!

The forward end of the centerboard case has been angled back so that it doesn't interfere with the mast stepping process. There is no need to lift the mast to put it through a hole in the deck – just place the foot of the mast in the step and push it forward into the mast partner. The whole process is a one-handed affair, which takes about thirty seconds.

I've put plenty of sail onto this boat, and for her to be able to stand up to it the rig needs to be kept low. A spritsail uses the shortest possible mast for a given sail area, and the sprit is reasonably short as well. The whole rig can easily be stowed within the length of the boat, making for hassle-free trailering.

Boomless sails are nice and simple, but they only drive a boat well if the sheeting geometry is correct. *Phoenix III* has been carefully designed from the outset to be able to operate without a boom on the mainsail. For those who prefer a boom (to ease sheeting loads, or to free up the choice of sheeting points), I recommend the use of a boom on the mainsail. Details for the boom are included with the plans package.

The centerboard is of generous area, and the centerboard case extends under the main thwart. With a centerboard shape reminiscent of that seen in Swampscott Dories, *Phoenix III*'s centerboard provides plenty of 'bury' in the case when fully lowered, while not interfering with the correct positioning of the rowing thwart.

There are buoyancy tanks built-in under the fore and aft decks, as well as under the aft thwart. A small, self-draining outboard motor splash well is also built into the aft deck.

If you want to row, the proportions of the rowing position must be correct, and the oars must be of the proper length. Also, the freeboard (i.e. the height of the sides of the boat above the waterline) needs to be quite low. *Phoenix III* has been designed to fit in with all the old rules-of-thumb, and she rows very easily. The centerboard case is shaped so as to allow the oarsman to lean back at the end of the stroke.

The hull is built upside-down on a normal strongback, details of which are in the plans. There are four permanent bulkheads and a number of temporary station molds made from MDF or construction ply.

All major components of the boat are made from 6mm/1/4in marine plywood, with small amounts of 12mm/1/2in for things such as the centerboard and rudder laminations. While she is not an 'instant boat', a determined amateur first time builder should be able to make a good job of

construction as long as he or she does some homework first. I strongly recommend Iain Oughtred's excellent book, "Clinker Plywood Boatbuilding Manual" as well as John Brooks and Ruth Anne Hill's book, "How To Build Glued-Lapstrake Wooden Boats".

As was so often advised by William Atkin and L. Francis Herreshoff, do not make changes to the design without consulting the designer. Everything in the design has been carefully thought through, and alterations could have serious consequences.

In response to the request of a New Zealand customer, I have drawn two additional rigs – a Balanced-Lug, and a Bermudian Sloop. Both of these rigs use the existing mast step and mast partner, so they can be added without alteration to the boat. In the case of the Balanced-Lug, the exact same mast from the Spritsail rig is used, but for the Bermudian Sloop a different mast is necessary.

Details for both of these rigs are contained within the plans package. The Balanced lug has a sail area of 76 sq.ft., and the Bermudian Sloop carries 89 sq.ft.

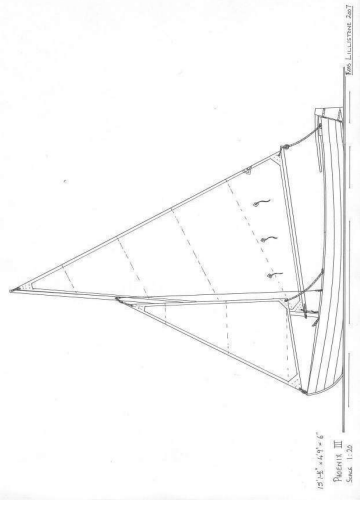
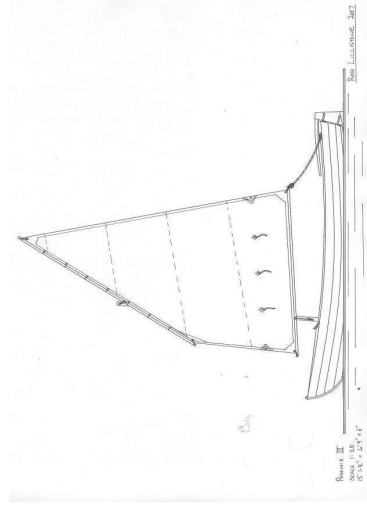

The plans consist of thirty (30) sheets of A3 drawings, plus photos. I have written a colour illustrated instruction manual of 41+ pages. This manual is included in the price of the plans package.

Price for the package is \$175.00 Australian including GST plus postage. Available from me, Ross Lillistone, PO Box 152, ESK, QLD 4312 AUSTRALIA  
Email: [bsam9350@bigpond.net.au](mailto:bsam9350@bigpond.net.au)  
Or from Duckworks at [www.duckworksbs.com](http://www.duckworksbs.com) (US\$155.00 including postage).

# **PHOENIX 3**

**Length** 15ft 1 1/2in / 4610mm  
**Breadth** 4ft 9in / 1457mm  
**Draft** 6in / 153mm  
**Sail Area** 104sq.ft. / 9.64sq.m.  
**Displacement** 595lbs / 270kg

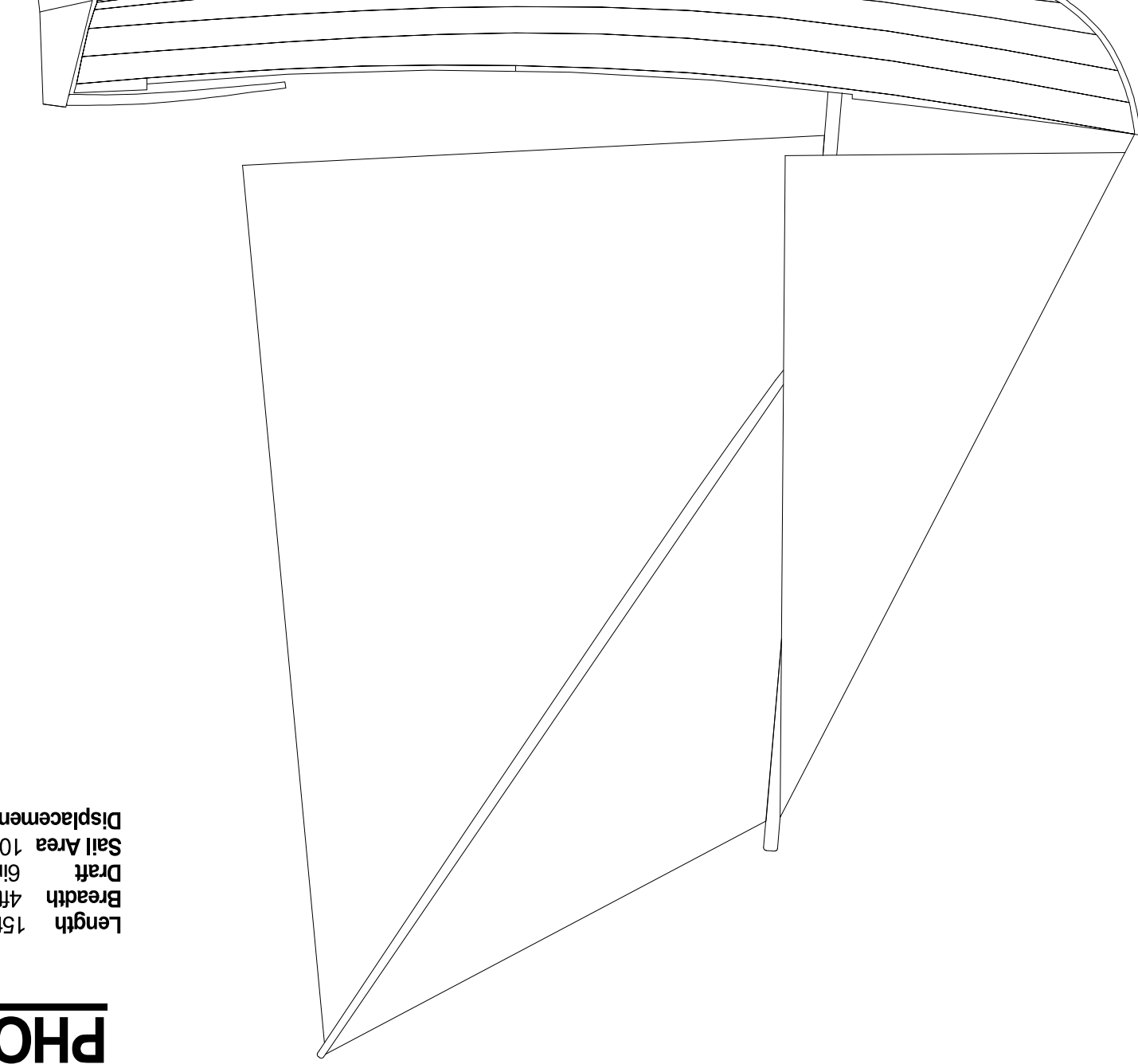

This design remains the property of Ross Lillistone, Bayside Wooden Boats. All rights reserved. Purchase of plans from the designer authorises the building of one boat to this design.

# Phoenix III

15ft 1 1/2in x 4ft 9in x 6in

Approximate deck layout in 6 mm Marine Plywood. Details of Carlings and Deck Beams/Knees shown on separate sheet.

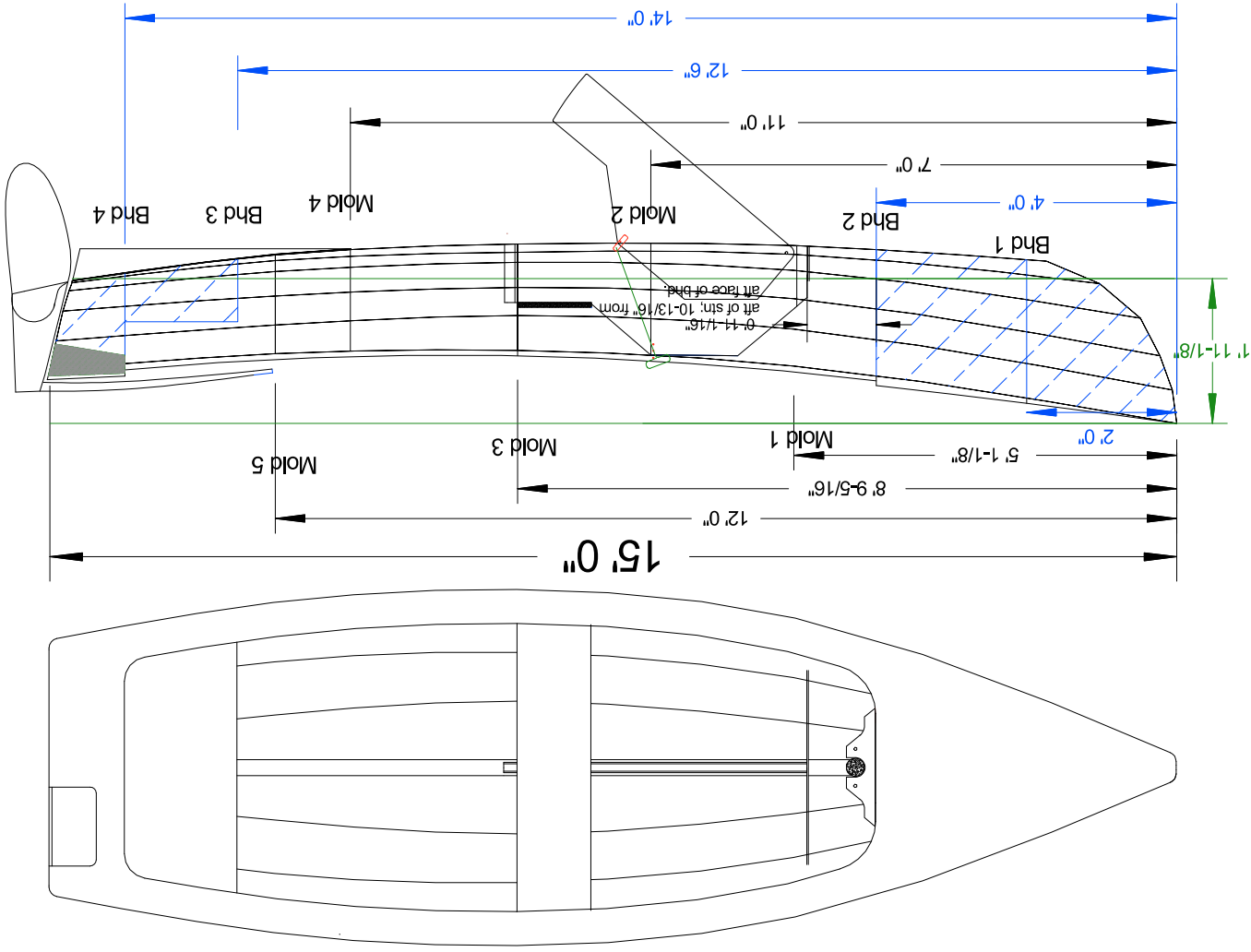

Study Sheet

Building plans available in metric or imperial editions

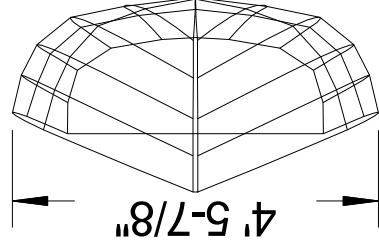

Dimensions to inside of planking.  
Scale 1:20

# Study Sheet

## Not to Scale

### Building plans available in metric or imperial editions

This design remains the property of Ross Lillistone, Bayside Wooden Boats. All rights reserved. Purchase of plans from the designer authorises the building of one boat to this design.

Strongback can be made from a variety of materials as long as it ends up level, and firmly attached to the work area floor. Suitable materials include pine house framing studs of approximately 75mm x 38mm (3" x 1 1/2"), although deeper side beams of about 150mm (6") are preferable to prevent sagging. My favourite side beams are made from LVL (Laminated Veneer Lumber) "Hybeams" of either 240mm or 300mm depth. These manufactured I-beams are quite economical and light in weight.

Dimensions shown are approximate, and can be varied to suit available materials and your preferred working height.

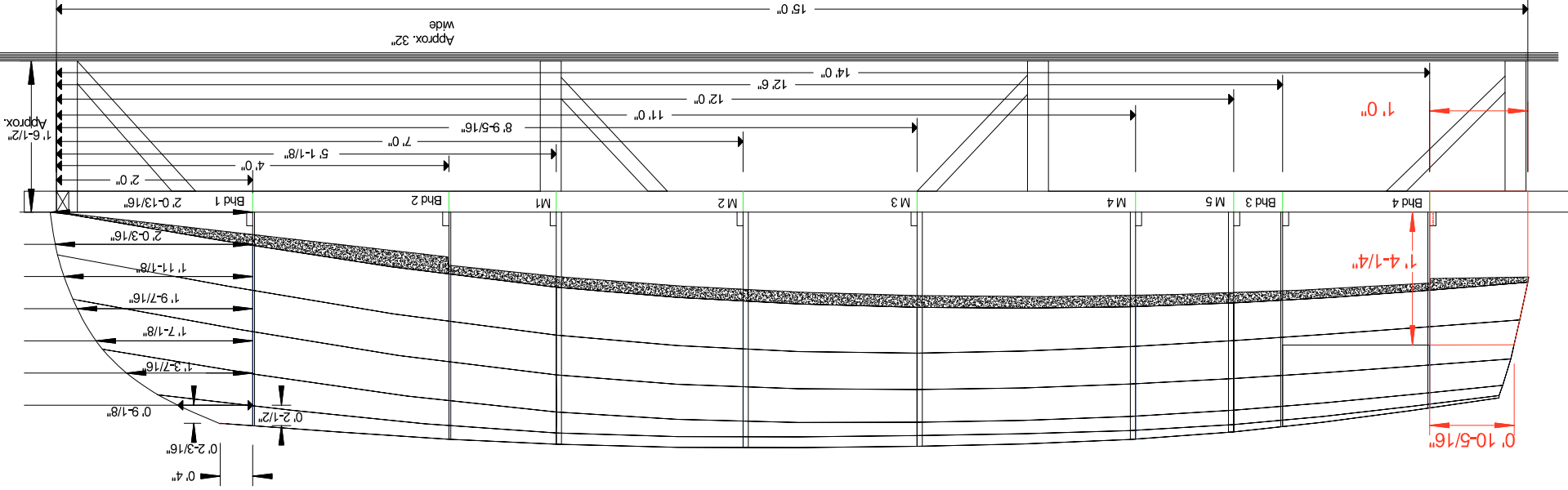
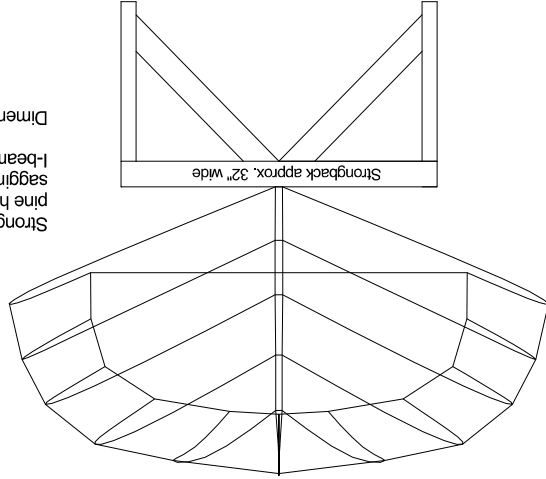

# Study Sheet

Not to Scale

Building plans available in metric or imperial editions

Scale 1:5

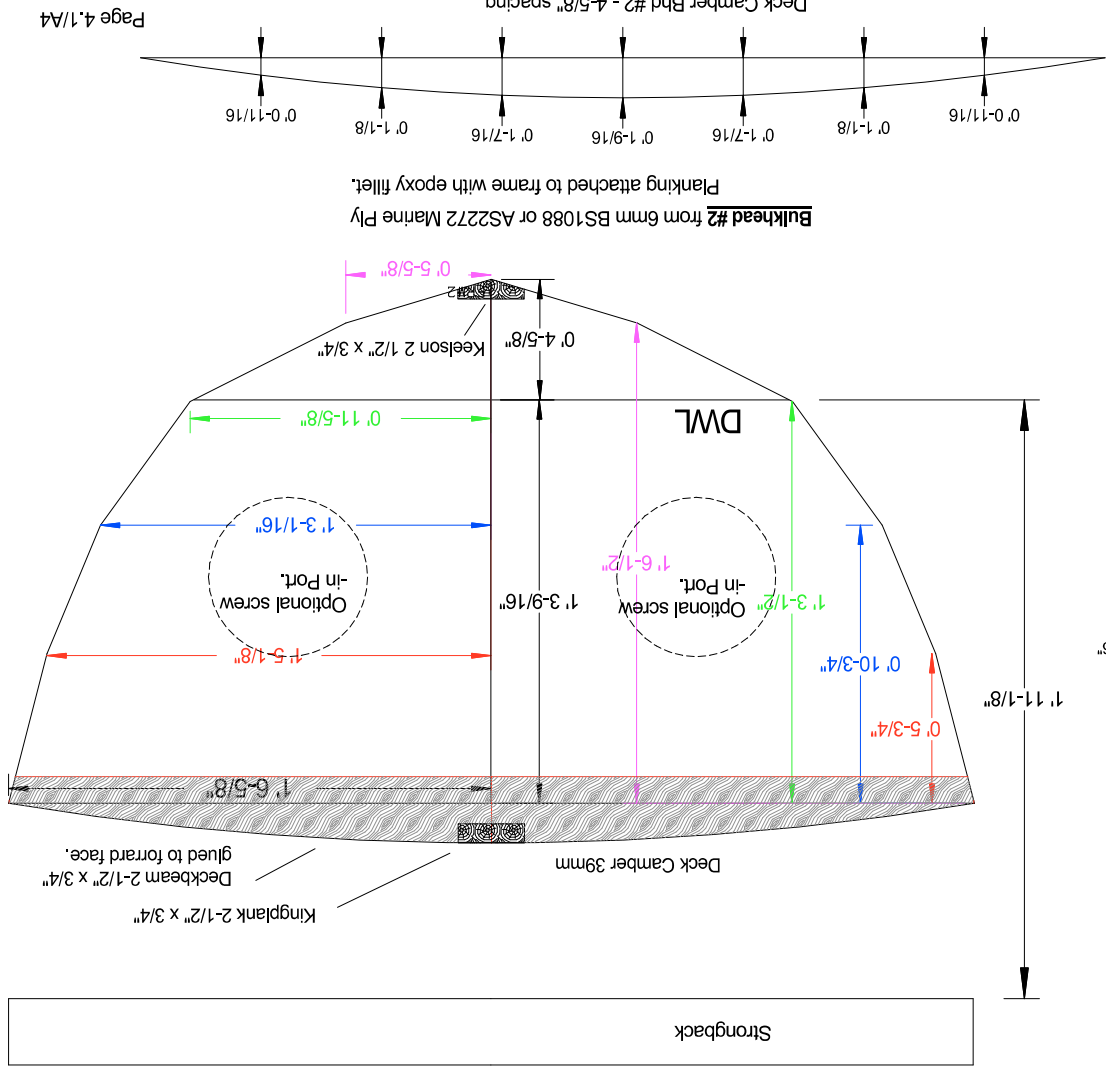
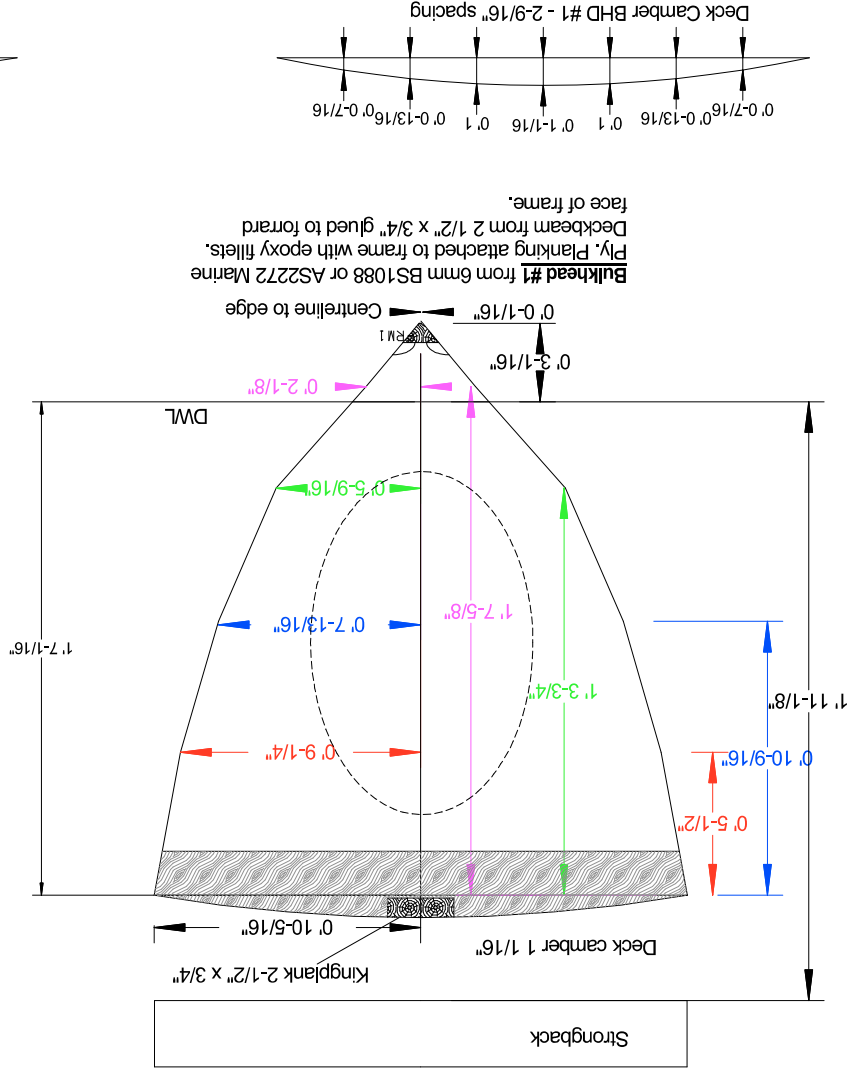

This design remains the property of Ross Lillistone, Bayside Wooden Boats. All rights reserved. Purchase of plans from the designer authorises the building of one boat to this design.

# Study Sheet

Building plans available in  
metric or imperial editions

Typical section, showing 1/2" plywood side deck knees and the 9/16" wide laps in the planking. Note that on the third lap down from the gunwale, the angle between the planks is such that the bevel reaches a feather edge before extending to the 9/16" lap line. This is accepted practice, and the resulting overhang should be filled with thickened epoxy. See large scale detail on next sheet.

This design remains the property of  
Ross Lillistone, BaySide Wooden Boats  
All rights reserved. Purchase of plans from  
the designer authorizes the building of one boat  
to this design.

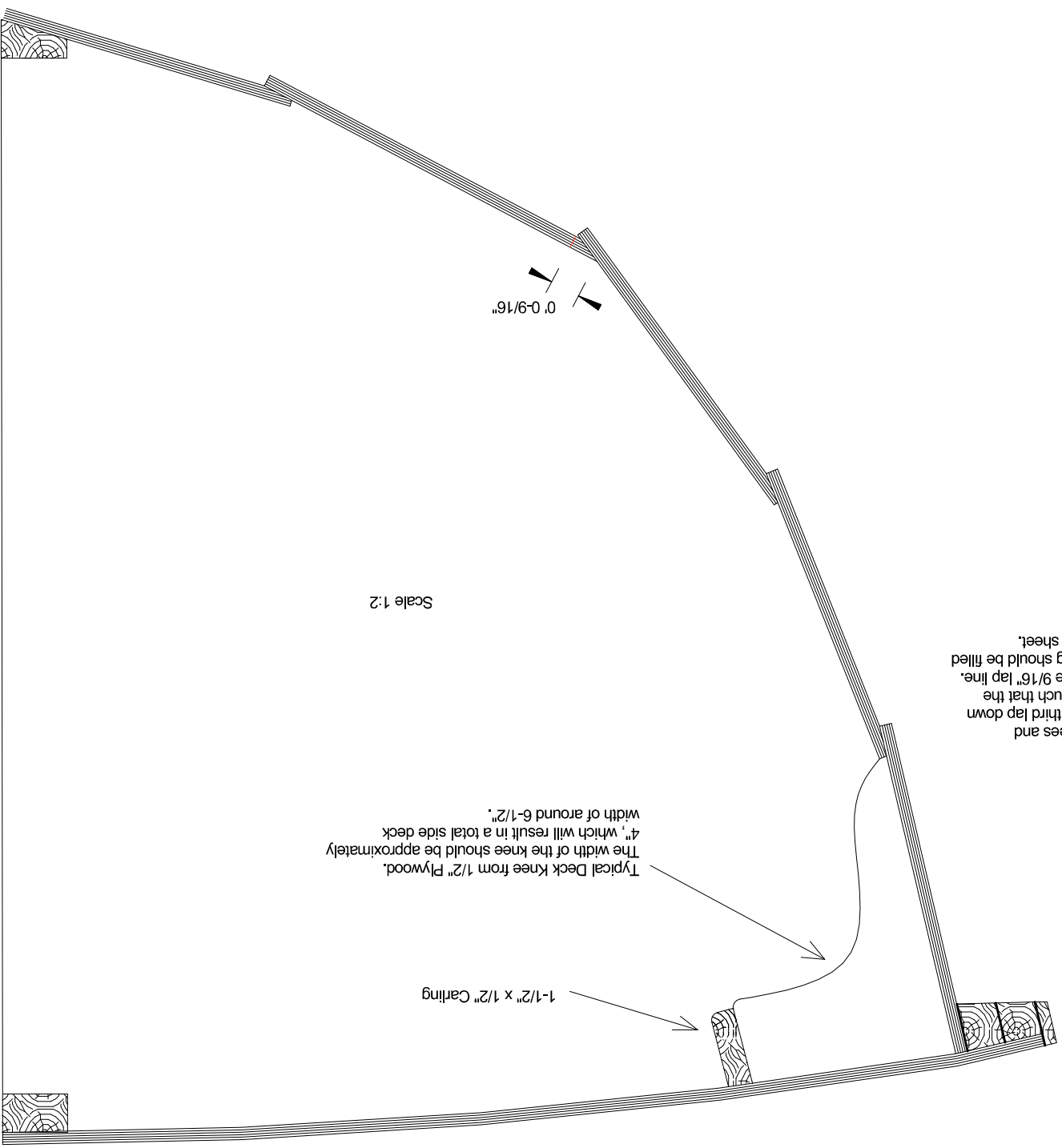



# Study Sheet

## Not to Scale

Building plans available in metric or imperial editions

Scale 1:12

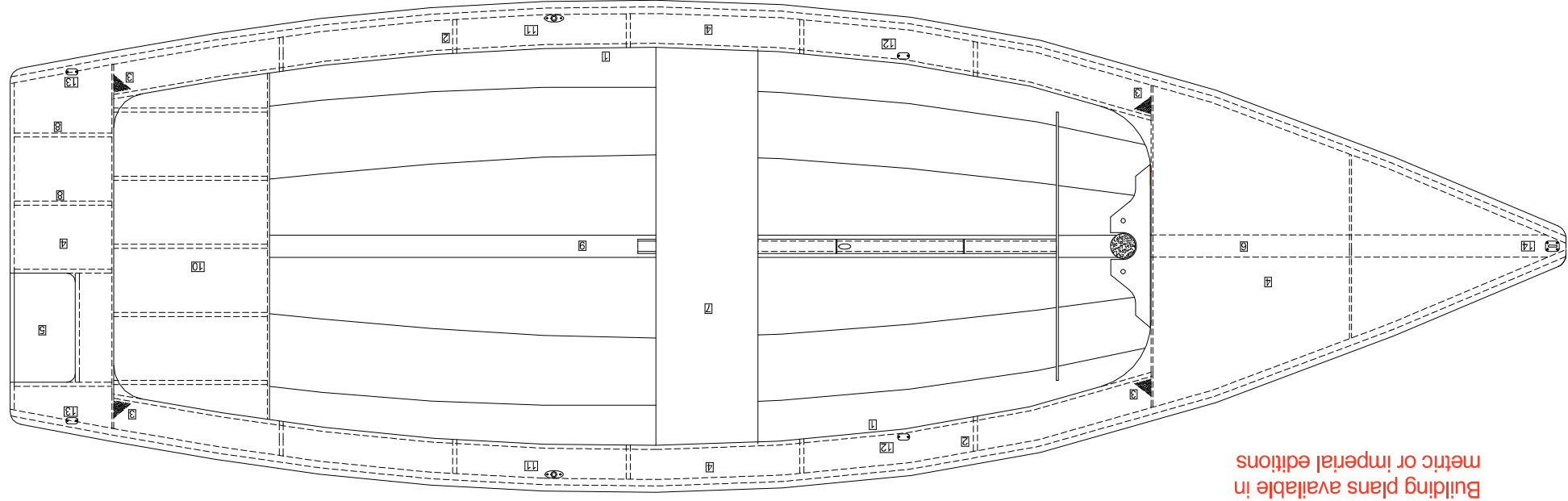

1. Deck Knees from 38mm x 12mm/1-1/2" x 1/2".
2. Deck Knees from 12mm/1/2" Ply - see sheet 21-A3. Molded dimension of top of knee approx. 100mm/4", which will give a total sidedeck width of approximately 164mm/6-1/2".
3. Corner blocks glued to carlings and bulkheads.
4. Decking from 6mm/1/4" Ply.
5. Outboard Well - optional - see sheets 17-A3 and 25-A3.
6. King Plank from 65mm x 19mm/2-1/2" x 3/4".
7. Thwart from 19mm/3/4" timber or Ply with timber bracing e.g. 6mm/1/4" with 38mm x 12mm/1-1/2" x 1/2" bracing or 12mm/1/2" with 25mm x 12mm/1" x 1/2" bracing - in any case, cut away bracing so that top of thwart is no more than 19mm/3/4" above top of centreboard case.
8. Aft Deck Framing from 38mm x 12mm/1-1/2" x 1/2" on 200mm/7-7/8" centres, glued to transom, aft bulkhead, and underside of deck.
9. Keelson from 65mm x 19mm/2-1/2" x 3/4".
10. Aft Seat/Tank Top from 6mm/1/4" Ply with 38mm x 12mm/1-1/2" framing on 200mm/7-7/8" centres, 12mm/1/2" Ply could be used with reduced framing.
11. Carlocks positioned 300mm/11-13/16" aft of aft edge of thwart. Use blocking under deck as required.
12. Jib Sheet fairleads positioned 1995mm/6'-9-9/16" aft of padeye on foredeck to which the jib is attached. Attach as far inboard on the side deck as is practical. Reinforce under deck with doubler to take bolts and distribute loads.
13. Mainsheet Fairleads positioned 185mm/7-5/16" forward of stern. Locate as far outboard as is practical.
14. Pad Eye or Eye Bolt firmly screwed to fore deck to act as attachment point for tack of jib. Set screws in wet epoxy.

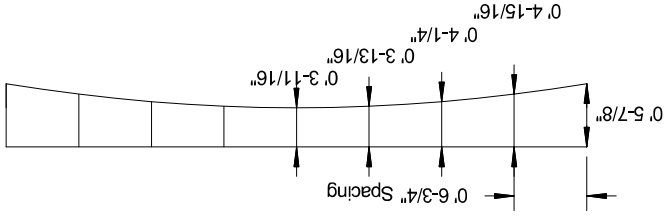

Pattern for camber of deck knees. Make from light MDF or scrap plywood, and lay across boat from sheer to sheer against deck knees. Trace underside of pattern onto side of deck knees and cut them down to the line.

This design remains the property of  
 Ross Lillistone, Bayside Wooden Boats  
 All rights reserved. Purchase of plans from  
 the designer authorises the building of one boat  
 to this design.

## **Sample page from instruction manual**

glue joint are avoided. Here is a drawing of a plywood scarp in cross section, showing the layers of veneer in the plywood and the glue line where the two beveled sheets of plywood meet. The slope of bevel which I use is 8:1. So for a piece of 6mm plywood, the distance that the bevel extends back from the edge of the ply is 6mm times 8 – which is 48mm.

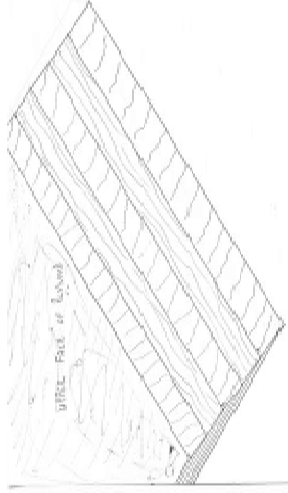
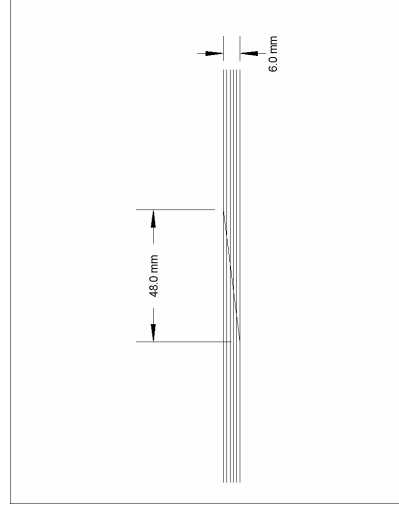

The easiest way to cut the scarp is with a sharp Low-Angle Block Plane. The job is much simpler than you might think and doesn't take more than about 15 minutes. Mark a line parallel to the edge of both sheets, but set back 48mm (in the case of 6mm plywood), or 2 inches (in the case of 1/4 inch plywood).

Stack the two sheets on top of each other with the edge of the top sheet lined up against the 48mm/2 in. line on the bottom sheet. This will allow you to lay the plane across the two sheets and will automatically start you off cutting at the correct 8:1 slope.

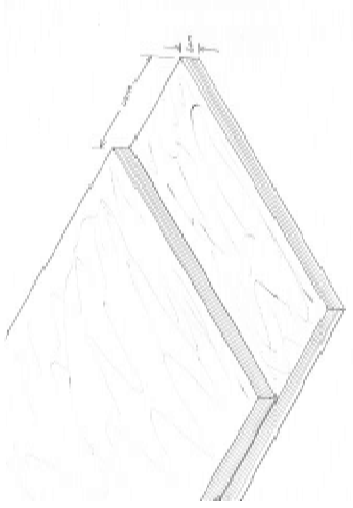

Here is a photo of four sheets stacked ready to have the scarp cut.



Cut the slope of the scarp evenly over the whole stepped surface. As you go, the scarp will start to appear as a series of lines as the plane cuts through the different veneers in the plywood. These lines are similar to contour lines on a map, and you will find that they give an excellent visual guide to how evenly you are cutting. Below is a photo of the scarps as they appear close to the end of the cutting process.



When the scarps have been cut to your satisfaction, they should come to a